

IMPACT™

SPRING ASSIST

- Increases torque by 50% and more
- Single unit
- Increase system reliability
- No external energy
- Dynamic reaction
- Namur interface
- Internal breather block

PATENT PENDING

 **HABONIM**
Industrial Valves & Actuators

DEDICATED TO INNOVATION

The Impact™ Spring Assist is a pneumatic device whose purpose is to increase spring closing torque on spring return actuators. This is achieved by diverting air pressure from the inner chamber to the spring chambers so that in combination with the spring force an increase in the total closing torque of the actuator is achieved.

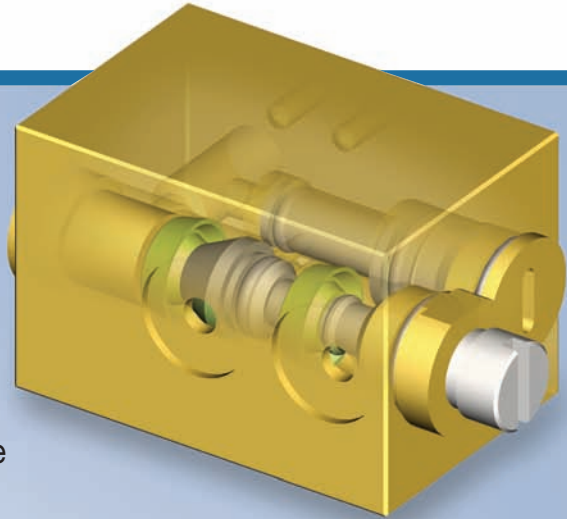

Redirecting the air pressure into the spring chamber increases the spring end torque by 50% and more.

IMPACT™ Cycle of Operation

Starting Point

The Impact™ full cycle of operation is illustrated below on a single-piston spring return actuator. In the initial startup the spring chamber and the centre chamber are not pressurized.

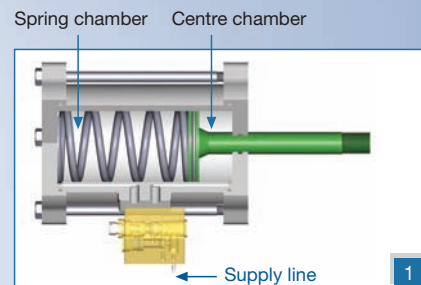

“ON” command to the actuator

At the ON command air pressure from the supply line is applied through the Impact™ and into the centre chamber of the actuator causing the piston to retract and compress the spring. The centre chamber stays pressurized until the OFF command is given.

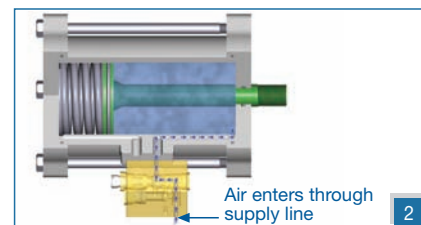

“OFF” command to the actuator

At the OFF command air pressure is directed from the centre chamber to the spring chamber as the spring pushes the piston back. The air pressure in the spring chamber and the centre chamber reach equilibrium.

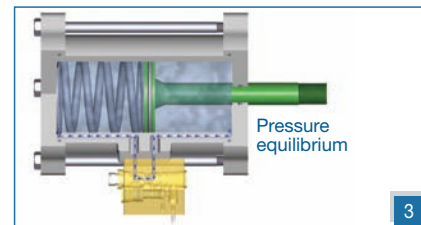

Spring End Position

As equilibrium is reached, the air in the centre chamber is released through the supply line it contributes additional force to the spring closing motion. Pressurized air is trapped until the next ON command.

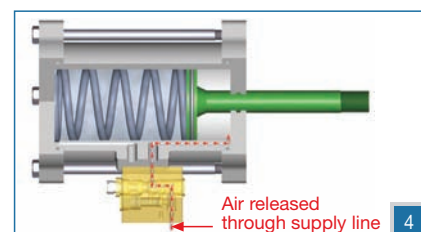

Next “ON” command

At the next ON command air pressure from the supply line is applied through the Impact™ and into the centre chamber and at the same time exhausting the trapped air from the spring chamber.

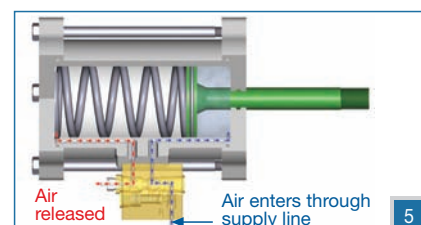



Applications

The Impact™ can be utilized directly on site where operating conditions may occur that cause functional disorders or become a safety issue. Some typical examples are given here:

1. Actuators that are not achieving their published torque output can have the Impact™ field mounted to improve their reliability without having to replace them or stop the process.
2. In situations where unexpected pressure drops occur, such as at beginning of a days work or when additional accessories are added to a system, the Impact™ will keep the pressure level at its maximum and prevent the actuators from shifting from their position.
3. In many cases it is possible to substitute a smaller actuator with the Impact™ and achieve the torque output of a larger actuator.
4. The Impact™ will increase the reliability and safety margin of existing actuators. The additional torque provided to existing actuators extend their life and reduce maintenance.
5. The Impact™ is ideal for critical applications where quick-closing actuators are required.
6. The Impact™ will help “self opening” valves keep their shut-off position.

Features

Adds 50% more torque

Redirecting the air pressure into the spring chamber increases the spring end torque by 50% and more. The torque generated depends on the type of valves in service and the operating conditions. The additional torque can be above 200%.

The Impact™ typical behavioural reaction to a spring return stroke is shown in the graph below. It is evident that the actual spring end torque is significantly higher with the Impact™.

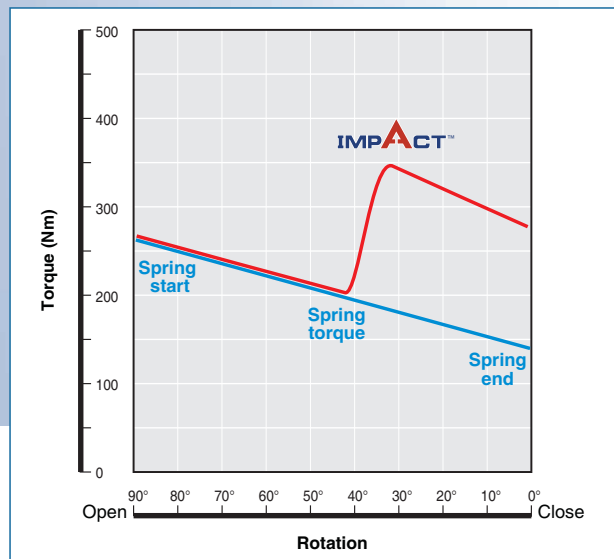

One size

The Impact™ comes in one size only which fits all size actuators making it a simple and easy solution for all the actuators on site or in inventory.

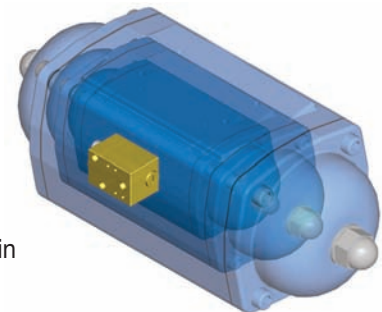

Used with any actuator

The Impact™ can be used with any type of spring return actuator, be it linear or rotary such as:

Rack and pinion (Single piston, Double piston, Four piston), Scotch-Yoke, Spring-Diaphragm, Vane type and Worm gear.

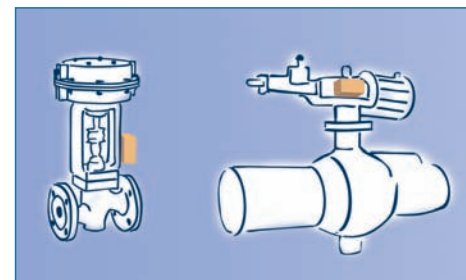

Safety and reliability

1. Pressure fluctuations

The Impact™ has a built-in non-return valve that will hold the maximum air pressure in the centre chamber so that any pressure fluctuations in the system will not cause spring return actuators to start closing and trigger alarms.

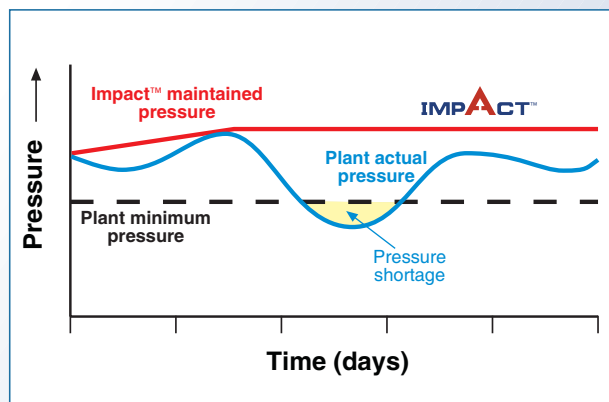

No additional air

The Impact™ does not need an additional source of air supply and does not require a safety backup system. The air used comes from the air already supplied to the centre chamber.

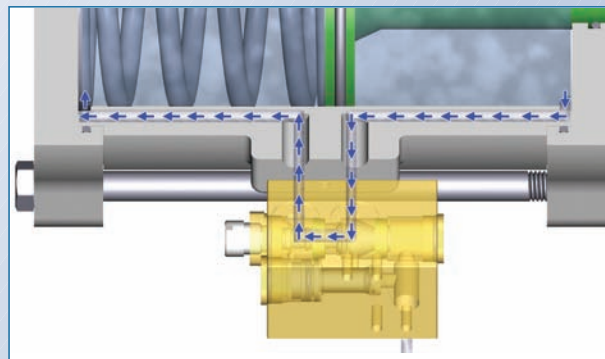

Built-in Breather block

The Impact™ has a built-in Breather Block that prevents suction of external air into the spring chamber (refer to Habonim Namur Breather Block catalogue).

2. Emergency cutoff

Under emergency situations the Impact™ will operate and react to any air supply cutoff. Unlike many other devices, the Impact™ is not dependent on an alternative air source.



3. No electrical hazard

The Impact™ does not operate on electric or electronic commands and therefore is not considered an electrical hazard.

Energy saving

The Impact™ does not operate on any form of external energy and is therefore a significant energy saver for its user.

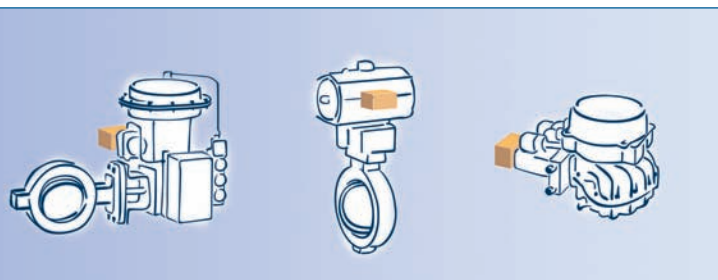

Namur interface

The Impact™ direct mounts to any actuator with Namur interface and has direct mounting for Namur solenoids. Only solenoids type 3/2 are required.



Non-Namur interface

By using a special insert plate the Impact™ can be used with any actuator that has standard threaded air connections.

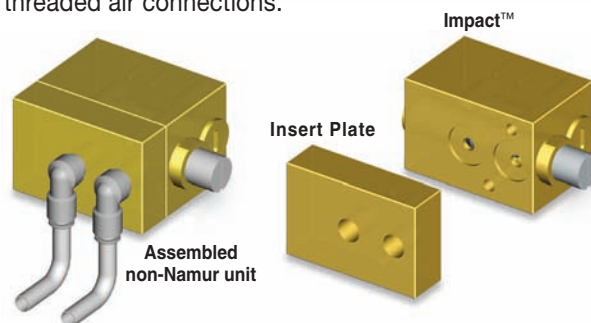

Compact size

The physical footprint of the Impact™ is slightly larger than a matchbox. The actual dimensions are 69 x 46 x 46 mm (2.716" x 1.811" x 1.811").

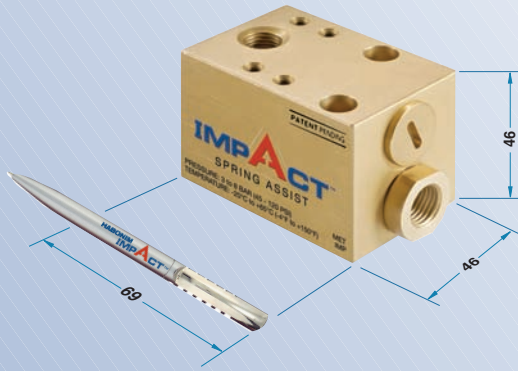

Quick shutoff

In cases where there is a requirement for increased closing speed for fail safe operations, the Impact™ provides faster closing due to the additional air pressure assisting the springs.

Self opening

When the actuator has closed the valve the Impact™ maintains the air pressure on the springs until the next operation. This gives the actuator a higher spring end torque which is ideal for "self-opening" valves. Because high pressure fluid loads the entire valve port it creates a force that acts against the actuator springs.

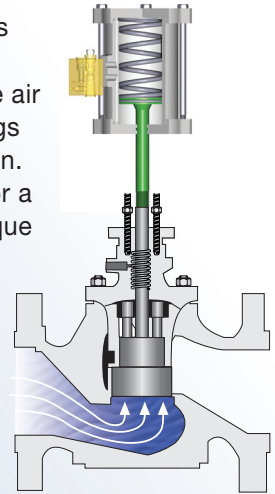

Reduce maintenance & inventory

Being only one size makes the Impact™ a great staff tool for the maintenance personnel on site and an economical solution for procurement.

Patented

The Impact™ is patent pending.

Dynamic responsive

The Impact™ unique design dynamically responds to valve torque increases and provides the extra air pressure to the actuator when it is required. Every valve type has its typical torque profile and spring action of the actuator is required to provide enough torque through the full stroke. The Impact™ responds to the actual conditions to give the additional torque. The Impact™ will also respond to situations where unexpected conditions can cause the valves to seize.

Ball valve torque

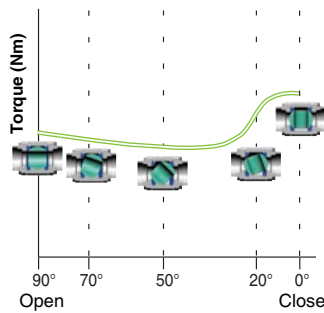

Butterfly valve torque

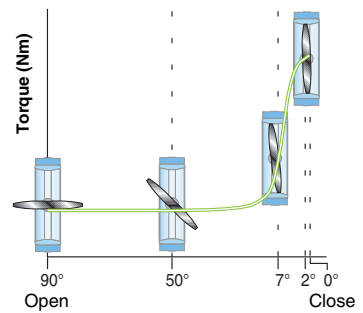

Plug valve

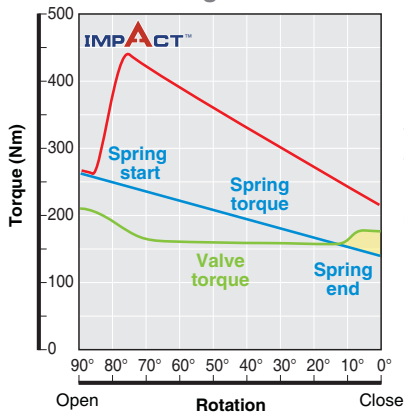

Ball valve

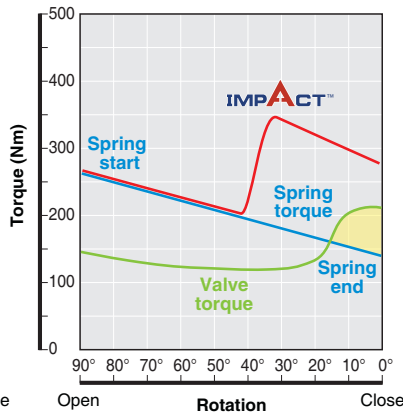

Butterfly valve

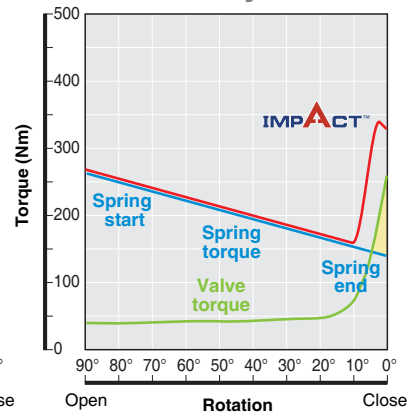

IMPACT™ How to calculate additional spring closing torque

The following steps will help you understand how to calculate the additional torque the Impact™ Air Assist will give your Spring Return actuator. The Impact™ will work with any type actuator, and you should use the torque tables provided by your actuator of preference:

STEP 1: Calculate Torque difference

In the Double acting Torque table find the actuator model and size that you are working with. Calculate the torque difference of 1 bar at any pressure.

Example shown:

The Spring Return actuator model size is C30 and the ΔP of 1 bar calculated is between 5.0 bar (73 psi) and 6.0 bar (87 psi).

The additional torque will be:

$130-107=23$ [Nm] ($1,150-947=203$ in-lb).

STEP 2: Calculate Spring Torque

In the Spring Return torque tables find the actuator model and size with the spring combination that you are working with. Locate the Spring End torque and add the additional torque as above.

Example shown:

The Spring Return actuator model size is C30 with 2C spring combination.

The Spring End torque is 44[Nm] (389in-lb).

The new Spring End torque will be:

$44+23=67$ [Nm] ($389+203=592$ in-lb).

$\Delta P = 1 \text{ bar}$

Double acting table

Model	Operating pressure (bar)					
	3.0	4.0	5.0	6.0	7.0	8.0
C15	10	13.5	17	20.5	24	27
C20	18	25	32	39	46	51
C25	39	52	65	79.8	91	105
C30	61	84	107	130	153	176
C35	114	152	190	228	266	304
C45	222	296	370	444	518	593
C60	527	703	879	1055	1231	1406

Spring return table

Model	Spring set	Air Stroke - bar (psi)			Spring Stroke	
		End	Start	End	Start	End
C15	1A	17	24	21	6	13
	1B	14	22	18	9	15
	1B2	11	20	15	12	17
	2	8.5	18	12	15	19
	2AB	31	43	37	12	17
C30	3	34	73	46	57	61
	2AB	14	152	136	35	21
	2A	107	148	129	42	26
	2A2B	96	143	118	53	31
	2B	87	138	109	62	36
	2A3	80	134	103	69	40
	2C	72	130	94	78	44
	2C3	62	125	85	88	49
	3	55	120	77	96	54
	2AB	105	139	102	109	59

Dimensions

Solenoid interface side

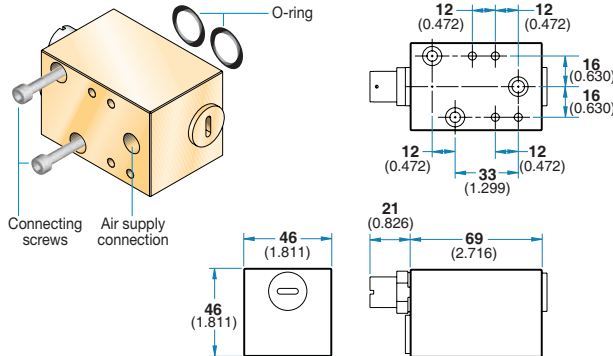

Actuator interface side

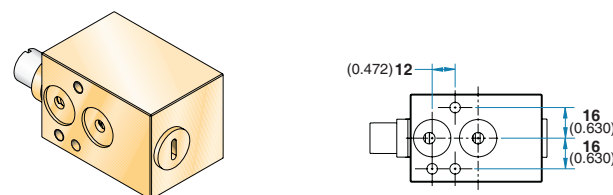

Specifications

- The Impact™ is environmentally protected by a hard anodized coating that is applied to all the parts both internally and externally.
- The temperature limits are -20°C to +80°C (-4°F to +176°F).
- The air supply pressure range is 3 to 8 bar (45 to 120 psi).
- The Impact™ will not operate at pressures below 3 bar (45 psi).
- The Impact™ is not affected by humidity, moisture, wetness or magnetic surroundings.
- Use only filtered air to 30 microns.

Ordering Information

Please provide all the information specified below:

Namur interface actuators:

IMPACT™-I : Imperial connecting screws thread type 10/24 UNC and air supply connection type 1/4" NPT.

IMPACT™-M : Metric connecting screws thread type M5 and air supply connection type G-1/4" ISO.

Non-Namur actuators:

As above but add the letter "X"

IMPACT™-I-X for Imperial / **IMPACT™-M-X** for Metric

All the Impact™ units are provided with the two connecting screws and two O-rings.



In accordance with our policy to strive for continuous improvement of the product, we reserve the right to alter the dimensions, technical data and information included in this catalogue when required. IMPACT™ is a trade mark of Habonim Industrial Valves & Actuators.

Copyright © 2008 HABONIM Ltd. All rights reserved



Headquarters Habonim ISRAEL
Tel: +972-4-6914911, Fax: +972-4-6914902
sales_international@habonim.com

ISRAEL
Tel: +972-4-6914903
Fax: +972-4-6914935
sales_israel@habonim.com

www.habonim.com

North America
Toll Free Phone: 1-866-261-8400
Toll Free Fax: 1-866-243-9959
sales_usa@habonim.com

Europe
Habonim Europe
Tel: +972-4-6914733
Fax: +972-4-6914703
sales_europe@habonim.com

U.K.
Habonim UK
Tel: +44-1633-484554
Fax: +44-1633-482252
sales@habonimuk.com

China
Habonim China
Tel: +86-21-6473-8523
Fax: +86-21-6445-3191
sales_china@habonim.com

Asia Pacific
Habonim-Vaas
sales_asiapacific@vaasval.com

India
Habonim - VAAS
Tel: +91-44-5224-8500
Fax: +91-44-5215-2473
sales@vaasval.com